

ITL10 Lampholder	busSTRUT	Lamp	Type	(F) Finish	Catalog Number
	BR	FOR USE W/PAR20, PAR30, & PAR38 LAMP (NOT INCLUDED)	LAMPHOLDER	SV = Silver BL = Black WH = White	BR-ITL10-P30-120-(F)

FEATURES

- Fixture can be used with Long Neck PAR30 lamps as well as PAR16, PAR20, and PAR38 lamps. Also has socket position for short neck lamps.
- Vertical slide adjustment slot allows numerous fixture heights.
- Half-yoke mounting design minimizes fixture presence.
- Precise, rigid aiming and full 350° horizontal rotation.

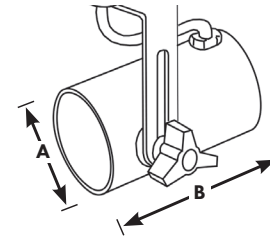

A	2-1/16"
B	2-7/8"

PAR30		busSTRUT READY GIMBAL			
ITL30 Gimbal	busSTRUT	Lamp	Type	(F) Finish	Catalog Number
	BR	FOR USE W/PAR 30 LAMP (NOT INCLUDED)	LAMPHOLDER	SV = Silver BL = Black WH = White	BR-ITL30-P30-120-(F)

ACCENTLIGHT

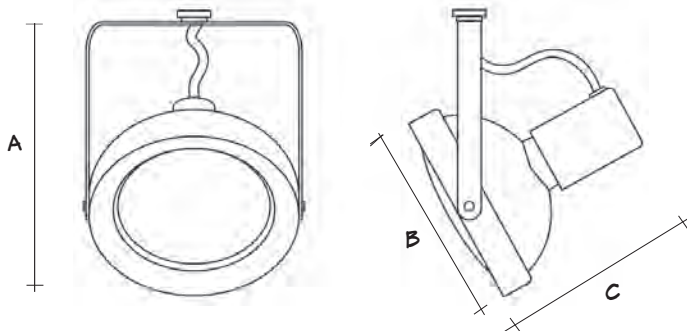

A	B	C
6 1/4"	3 3/4"	4 1/4"

Description:

- Specifically designed for accurate aiming and position holding
- Back loaded lamp screws into socket holding it firmly in place

Features:

- Light weight, strong construction
- Clean style
- Adjustable for precision aiming

Lamp:

-FOR USE WITH PAR30 LED (LAMP NOT INCLUDED)

Socket:

-E26 Medium Base

GIMBAL RING PAR- 20 / 30 / 38	busSTRUT	Lamp	Life (HRS)	Type	CRI	Lamp lm	Fixture lm	Watts	lm/w	Beam	CBCP	(F) Finish	Catalog Number
	BR	LED		Accent									B = Black W = White N=Natural

ACCENT LIGHT



PAR-20

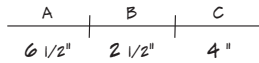

PAR-30

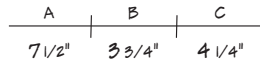

PAR-38

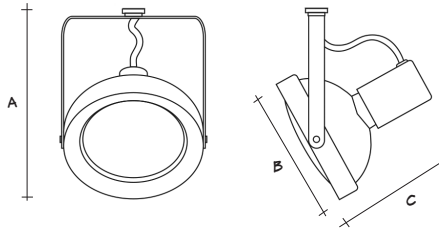
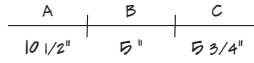

Description:

- Specifically designed for accurate aiming and position holding
- Back loaded lamp screws into socket holding it firmly in place

Lamp:

- PAR 20/30/38

Socket:

- E26 Medium Base

Features:

- Light weight, strong construction
- Clean style
- Adjustable for precision aiming

FEATURES

- Fixture can be used with Long Neck PAR30 lamps as well as PAR16, PAR20, and PAR38 lamps. Also has socket position for short neck lamps.
- Vertical slide adjustment slot allows numerous fixture heights.
- Half-yoke mounting design minimizes fixture presence.
- May be track mounted or used in mono-point applications with the LA-18 mono-point accessory.
- Precise, rigid aiming and full 350° horizontal rotation.

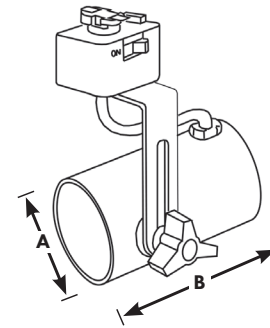

A	2-1/16"
B	2-7/8"

busSTRUT	FINISH	CATALOG NUMBER
BR		BR-(F)

COMPATIBLE LAMPS:

(Not Included)

- PAR 16, 75W
- PAR 20, 50W
- PAR 30, 75W
- PAR38, 250W

SOCKET:

- E26 Medium Base, 120V

FEATURES

- Constructed of die cast painted aluminum to provide superior strength and rigidity. All edges are softened for aesthetic appearance
- Fixture provides horizontal rotation of 358°. Adjustable yoke provides vertical rotation of 90°, which adds to a versatile directional lighting and total control of light positioning.

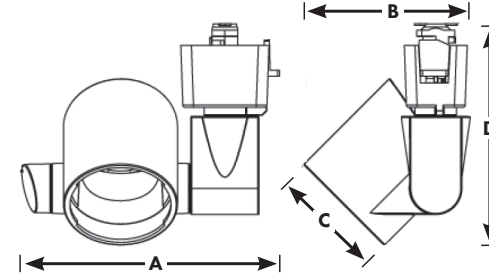

A	4.6"
B	3"
C	2.1"
D	4"

busSTRUT	FINISH	CATALOG NUMBER
BR	White (W) Black (B)	BR-(F)

COMPATIBLE LAMPS:

(Not Included)

- PAR 20, 50W
- Short Neck PAR 30, 75W
- PAR38, 250W

SOCKET:

- E26 Medium Skirted Base, 120V

SHADES



PAR 20
P20S-B-W
Black



PAR 30
P30S-B-W
Black



PAR38
P38S-B-W
Black



PAR 20
P20S-W-W
White



PAR 30
P30S-W-W
White

PAR 38
P38S-W-W
Black